

### 1. INTRODUCTION

Grove Collection™ are V-Groove Planks, Beadboards, Crown & Bed Mould in 6 stunning woodgrain colors. These are made with cellular PVC and a beautiful PVDF woodgrain finish for long-lasting beauty and low maintenance.

### 2. MATERIALS & TOOLS LIST

- Miter saw, (minimum 80 tooth on a 12" blade for finish cuts)
  - For max results us CMT 96 tooth fine finish (12")
- Level
- Pencil
- Square
- Tape measure
- Pneumatic/battery nailer
- 1-1/2" to 2" stainless steel crown staples 1/4"-1/2" wide
- 2" 8D stainless steel nails with annular threads
- Trim head screws for best results

#### PERSONAL PROTECTION EQUIPMENT

- Eye protection
- Gloves

**Safety Note:** Like when cutting wood, avoid breathing dust. In case of inadequate ventilation, use a dust mask. Follow all tooling manufacturer's instructions.

### 3. APPLICATIONS

These are ideally suited for soffit and under porch applications in all climates. Always follow your local building codes to ensure compliance. Not for siding applications.

### 4. STORAGE & HANDLING

- Keep product in the package and stored on a level surface until ready to install.
- Do not store in heat exceeding 120°F.
- Avoid installing product below 40°F. When installing below 40°F you must predrill for fastening.
- For best results, use two people to handle and install the product.
- Do not slide product out of the crate or against each other and handle the product with care as to not scratch the surface (face to face and back to back).

**Warning:** Do not allow contact with acetone and/or solvent-based cleaners or adhesives at any time.

### 5. PREPARATION

- Prior to installation, ensure the rafters are true, level and spaced at maximum 16" OC apart.
- If needed, use shims to create a flat surface.
- Measure the width to be covered and divide it by the exposed surface of the board. If the last board is less than 2" wide, trim the first board for even spacing.

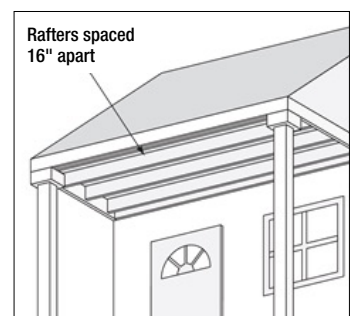
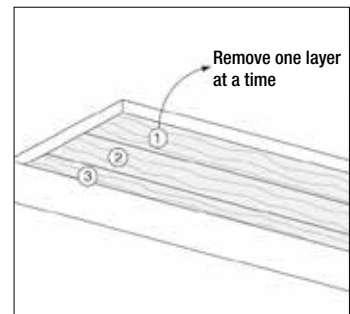

## 6. INSTALLATION

- For the best results use two people to install this finished product.
- Grove Collection are pre-sorted in each package to ensure woodgrain variations.
- Remove each piece from the original package one layer at a time from right to left and top to bottom to ensure proper variation of woodgrain.
- Boards are not precision cut. End cut trim pieces to square up ends if necessary.
- Measure the length of each board to allow 3/8" space on each end.
- Start with the groove side and place it against the starting location.
- For best results apply adhesive to the framing or sheathing just prior to securing the beadboard with nails and staples.

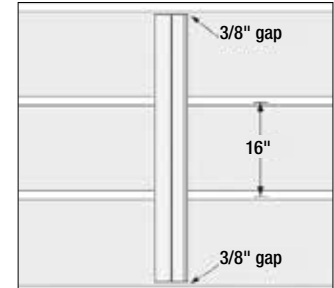
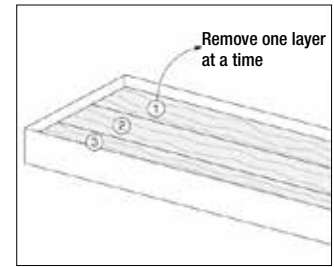

## 7. NAILING

- Use 1-1/2" stainless steel crown staples or equivalent in the nailing hem and 2" 8D nails or equivalent for face nailing to ensure proper penetration into framing (in temps below 40°F, predrilling is necessary).
- Position the first piece tongue side to the starting location and face nail (2) 8D nails at each framing location.
- On subsequent pieces, place the tongue firmly into the groove and secure with crown staples in the nailing hem at each framing location.
- You may need to cut the last board, lengthwise to finish your installation.
- Use (2) 8D nails at each framing location on your last piece.
- When complete, install Grove Collection crown or bed moulding around the perimeter to cover the 3/8" gap.

**Note:** Ensure the staples are flush or just below the surface of the nailing hem.

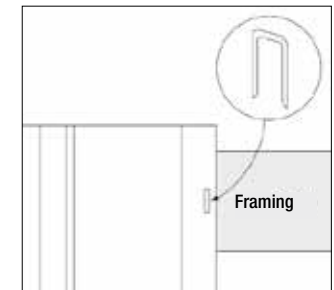
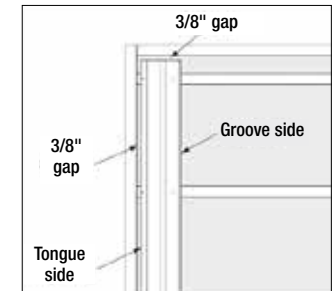

## 8. CLEANING & CARE

**Do NOT use abrasive scrub pads, pumice-based cleaners or solvents like acetone and toluene.**

- Clean with a mild cleaning agent and soft cloth.
- Westlake Royal recommends COSMOFEN 20 PVC cleaner (CL-300.140 Weiss) for general cleanup.
- Ensure proper ventilation around your installation to prevent heat buildup.
- Use Grove Collection paint daubers to conceal any white substrate that may show through.

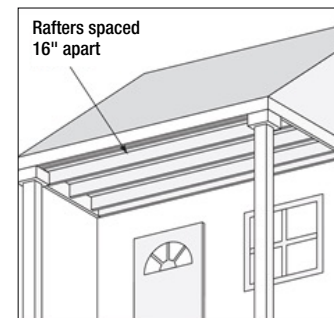

**Westlake**  
Royal Building Products™

© 2024 Westlake Royal Building Products

Royal® Trim & Mouldings  
RoyalTrimMoulding.com | 855-769-2585  
RTM240500 7/24